

Konstruktionsopgave 1. trin 6

Emnetegning

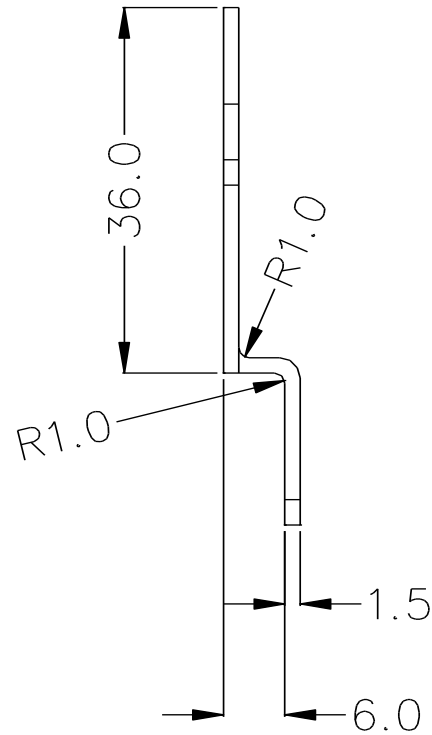
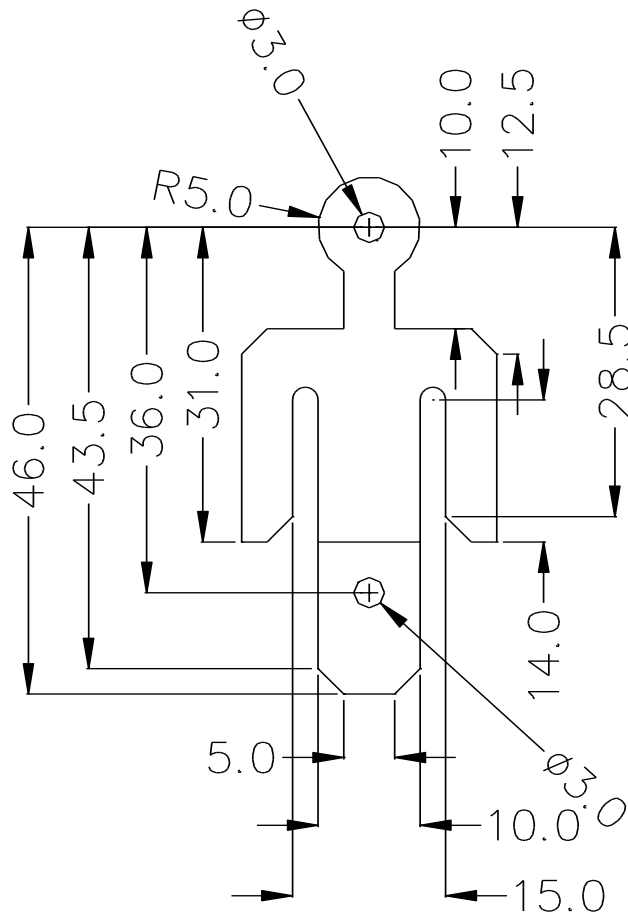

Materiale St. 1203 middel hårdt

Rmt. 410 N/mm

Valgfri grat side - 33% blankzone

Antal emner 500.000 stk.

Tolerance D.S.2075 fin